

FERMAX

MIO/WIT MONITOR INSTALLER'S MANUAL

ENGLISH Version

Cod. 970135lc V07_19

This manual corresponds to MIO/WIT Monitor firmware version V02.10.

FERMAX ELECTRÓNICA S.A.U.

<http://www.fermax.com>

MIO/WIT Monitor manual available at <https://www.fermax.com/qr/meet/>

Copyright Notice

Fermax and Fermax MIO/WIT monitor are trademarks of Fermax Electronica S.A.U. registered in the European Union and other countries.

© FERMAX ELECTRÓNICA S.A.U., 2019.

INDEX

1	Product Introduction	5
1.1	Overview	5
2	Functions Overview	5
3	Function Introduction	6
3.1	Call Reception And Release lock	6
3.2	Audio setting	7
3.3	Extended Unlock	8
3.4	Switching to IP Cameras related to the panel	9
3.5	Concierge Calls	10
3.6	Panel Auto On	10
3.7	Auto On-IP Camera	11
3.8	Door release for IP CCTV Camera	12
3.9	IP Camera activated by Door Bell	12
3.10	Intercom	13
3.11	Call Log	13
3.12	Alarm	14
3.13	Lift Control	15
3.14	Message	16
3.15	SOS	16
3.16	Actuators	17
3.17	Scenes Control	18
3.18	Do Not Disturb	18
3.19	Ringtone Setting	19
3.20	Screen Setting	19
3.21	Language Setting	20
3.22	Date/Time Setting	20
3.23	Alarm Pincode Setting	21
3.24	Installer Settings	22
3.24.1	Monitor Settings	23
3.24.2	SIP Settings	24
3.24.3	Alarm Setting	24
3.24.4	Modes Setting	25
3.24.5	FUNCTIONS	26
3.24.6	APP Applications	26
3.25	About	27
4	Configuration via Web Server	28
4.1	Device Information	28
4.2	General Settings	29
4.3	BLOCK: 3 digits (001-999) = block number	29
4.4	Network Settings	30
4.5	IP Camera Settings	31
4.6	SIP Settings	32
4.7	Advanced Settings	33

4.8	Relay Control	34
4.9	Verification	34
4.10	Pincode Settings.....	35
4.11	RESTORE.....	35
4.12	Log Out.....	36
5	Installation	37
5.1	Schematic Diagram Of Installation	37
5.2	Connectors	38
5.3	Wiring Diagram For Alarm	39
5.4	Technical Parameters	40

1 Product Introduction

1.1 Overview

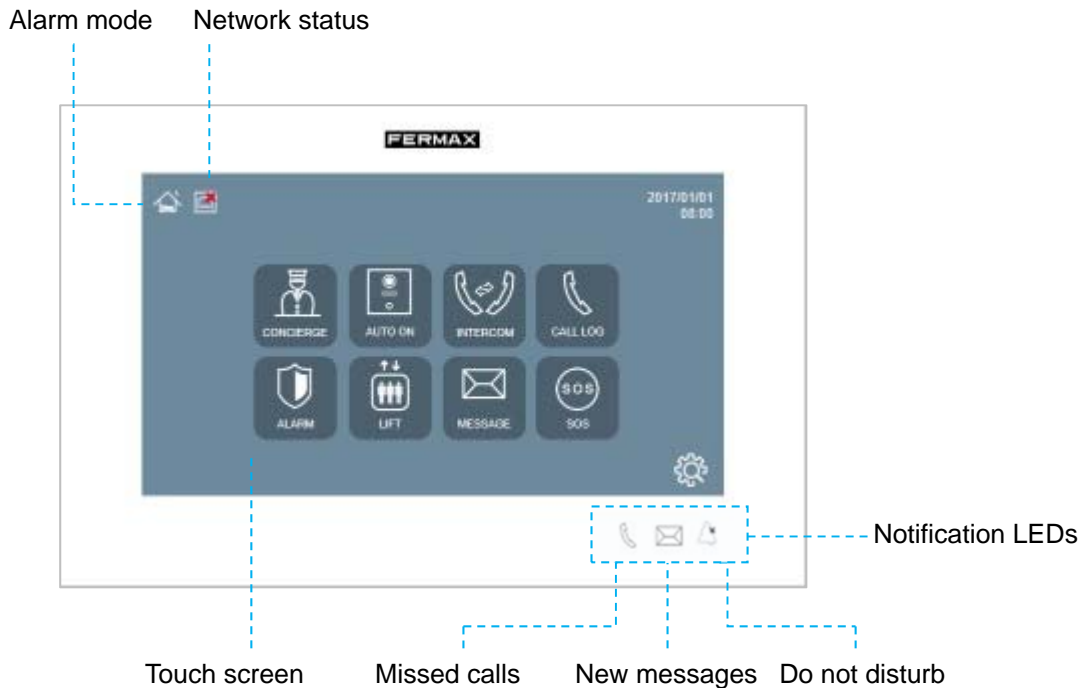

2 Functions Overview

- Call reception and door lock release
- Call to concierge
- Panel auto switch on
- Apartment to apartment intercom
- Messages
- Alarms (Only when installed)
- Lift control (Only when installed)
- Relay Control (Only when installed)
- Scenes control
- APP Applications
- SOS
- Do not disturb
- Ringtone setting
- Screen setting
- Date/Time settings

3 Function Introduction

3.1 Call Reception And Release lock

Monitor can send or receive calls from:

- Outdoor panels
- Guard Units
- Other apartments in the same installation

The monitor can establish conversation, capture pictures and release door lock when the monitor is connected to the outdoor panel.

REMARK: The monitors with same room number can't call each other.

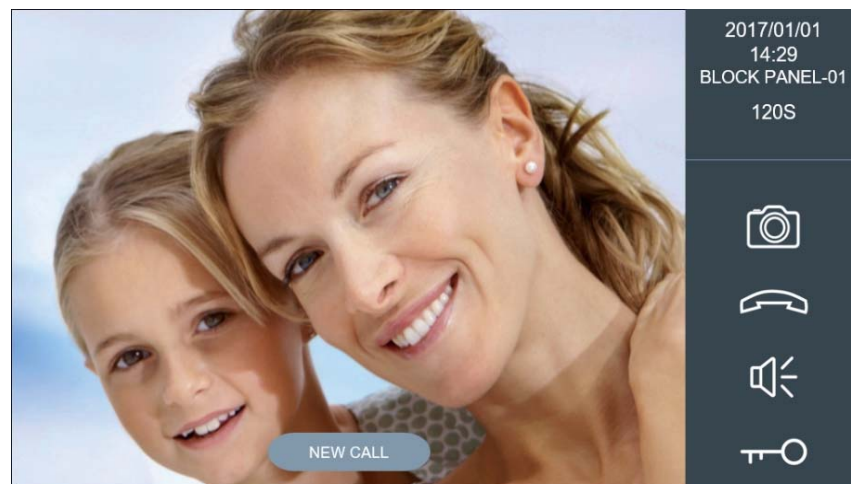
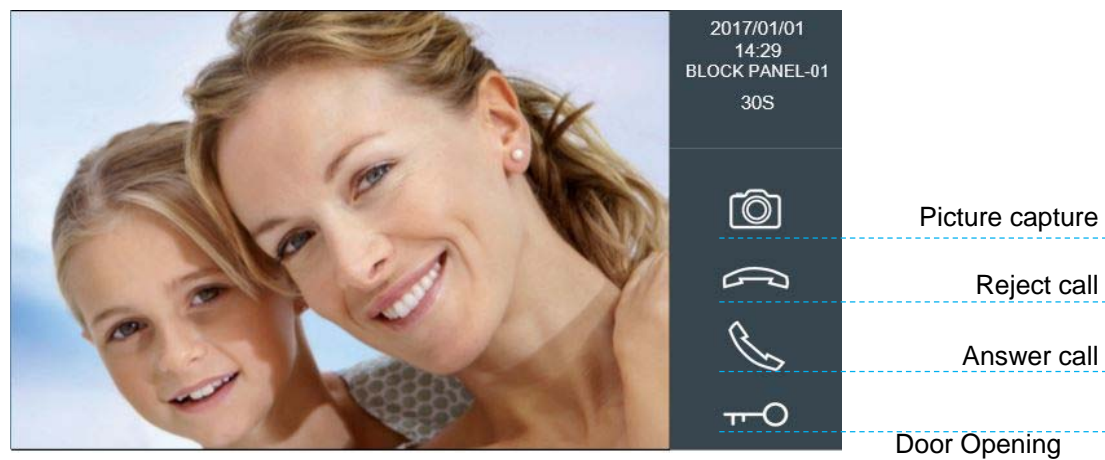

When the monitor is on communication, if it receives a new call from Door bell or an Alarm, a text prompt will be displayed.

3.2 Audio setting.

The audio volume can be adjusted with the setting bar. This volume adjustment bar is only available when the audio is active.



You can press up or down volume icon, the volume will be saved automatically.



MUTE: Temporarily turn off the microphone, to prevent an indoor conversation from being heard at the outdoor panel.



3.3 Extended Unlock

If extended relays are defined in the monitor, a menu with more unlock options will be displayed after the resident touch release lock icon. The resident can select and activate any of the 4 relays available on the ref.1491 4 Relay module connected to the panel. The number of relays used for extended unlock can be set on monitor's web server setup.



3.4 Switching to IP Cameras related to the panel

The monitor can switch the video to an auxiliary IP Camera when the monitor is in conversation with the panel. The number of the IP cameras can be set on web server of the monitor. 0-4 optional.

The settings related to the IP cameras (like door lock relationship) need to be setup on the web server of the panel.



3.5 Concierge Calls

The resident can call to any available concierge by selecting it from the concierge list. Only 9901, 9902, 9903, 9904, 9905 will appear in the list.

If the concierge does not answer, the user can leave a message if this function is enabled on the guard unit.

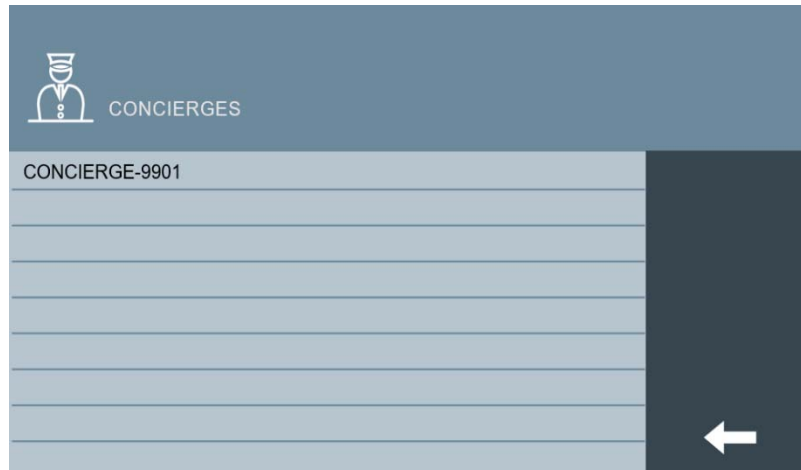

3.6 Panel Auto On

The resident can select any available outdoor panel from the panel list. After auto on, the monitor will receive audio and video from the panel (no audio from monitor to the panel will be sent) . The monitor will send audio to the panel if answer call icon is pressed on the monitor.

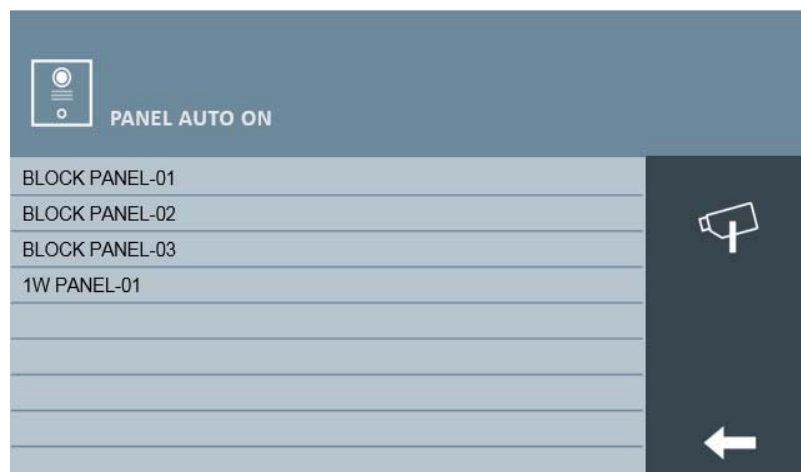

REMARK: Panel auto on function is available only for block panels and 1W panels. Not available for General entrance panels. Only block panel numbers from 1 to 9 will appear on the list.

3.7 Auto On-IP Camera

Touch the **IP Camera** icon.

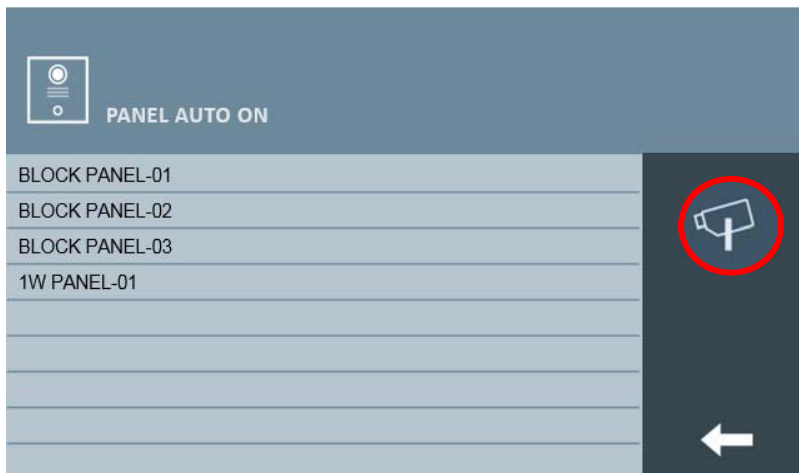

The name of IP camera will be shown in the IP camera list interface. Maximum of 8 IP cameras can be displayed.

Select the desired camera to display the image. The video of IP camera will close if the panel or guard unit calls to the monitor. The video of IP camera will not close if the door bell is activated.

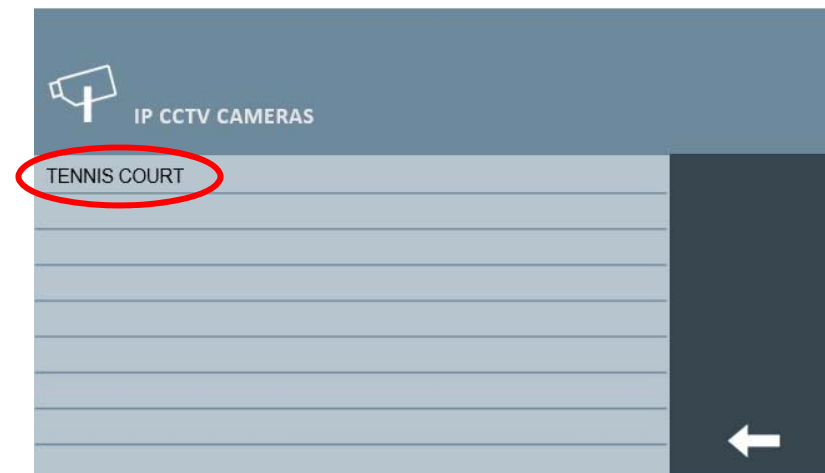

REMARK: The camera still appears in IP camera list even if the IP camera is disconnected from the network. There is no autodiscovery process on IP cameras.

3.8 Door release for IP CCTV Camera

The resident can open the door lock related to an specific CCTV camera just pressing the key button. This key button will open the lock associated to each CCTV camera. These locks can be selected from the ref. F01491(4 relay module) connected to panel 1.



3.9 IP Camera activated by Door Bell

The monitor will display the video of a selected IP camera when the doorbell is activated. This function can be set at 'IP Camera' settings on the monitor's web browser.



3.10 Intercom

The resident can call to other apartments by dialing the apartment's number.
To call to other apartment at the same block, only input the apartment number.
To call to other apartment at others block it should be used the complete monitor number (block number + apartment number), and click the calling icon. For example, call to block 1 and apartment 0101, input 10101 and press call icon. The system will automatically add "0" in before the block number.



3.11 Call Log

If there are events with a camera icon on it, the user will be able to review the photo done during the call by double clicking event.

The image will appear.

Click the export pic. Icon can export photos to Micro SD card.

The user can delete all call logs or one call log.

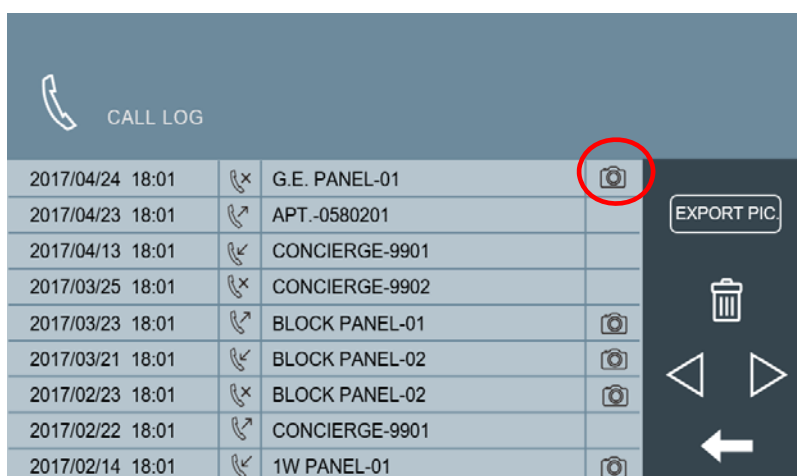

3.12 Alarm

■ Alarms (Only when installed)

Home mode: sensors set to be active under home mode will be armed.

Sleep mode: sensors set to be active under sleep mode will be armed.

Out mode: sensors set to be active under out mode will be armed.

The resident can change the mode of the alarm by simply clicking on the mode icons available on this interface.

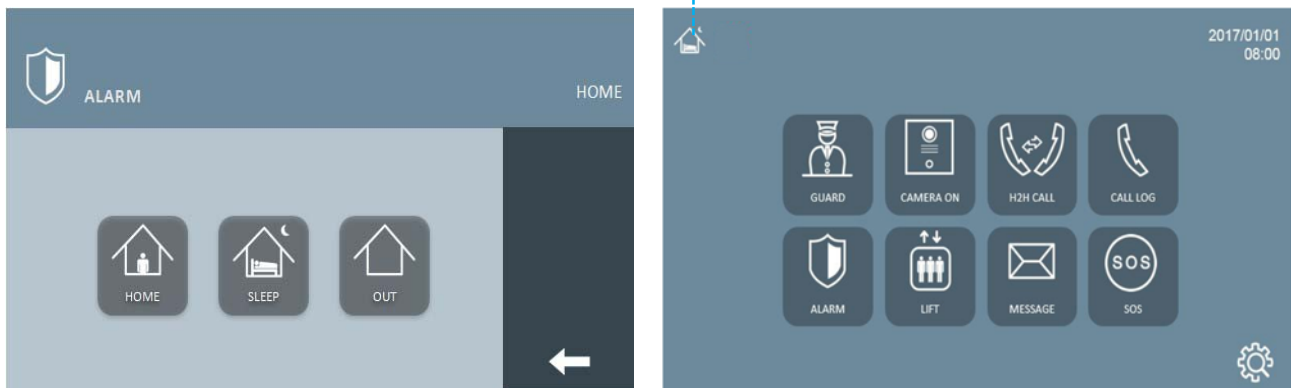

Out mode is the highest security mode followed by Sleep mode and Home mode respectively. To change from a higher level to lower level, the resident will be requested to enter a disarm pincode.



REMARK:

Default factory user pincode is 1234, distress pincode is 4321.

In case the resident is forced to deactivate the alarms against his willingness, he can enter the distress pincode which deactivates the alarm but sends a distress alarm to the Guard Unit at the same time.

3.13 Lift Control

■ Lift Control (Only when installed)

The resident can call the lift through touch **UP** or **DOWN** icon when the resident plan to leave home, the elevator will arrive to resident's floor.

The monitor can show state of elevators if MEET system captures data from elevator (high level lift control integration is required)

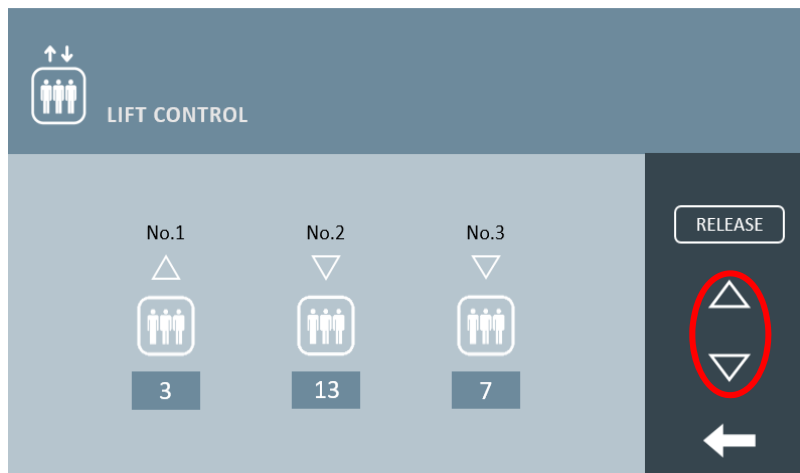

The resident can authorize the lift floor through touch **RELEASE** icon. This is used when a neighbour in the same block wants to visit the apartment after calling through intercom and pressing **RELEASE** icon after the conversation ends.

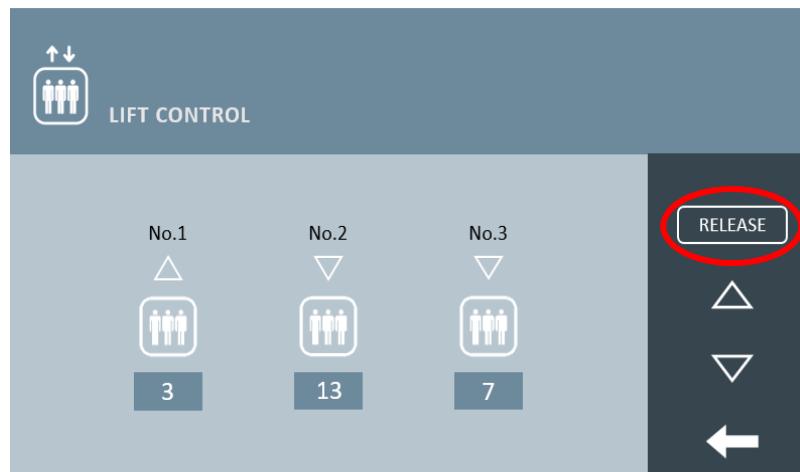

REMARK: Please see manual of MEET LIFT CONTROL GATEWAY if you want to know more information about lift control.

3.14 Message

The notification LED will light up and notification sound will be sent when a new message is received. The LED will off after the resident reads all new messages, the resident can delete messages in the message list.

The user can delete all messages.

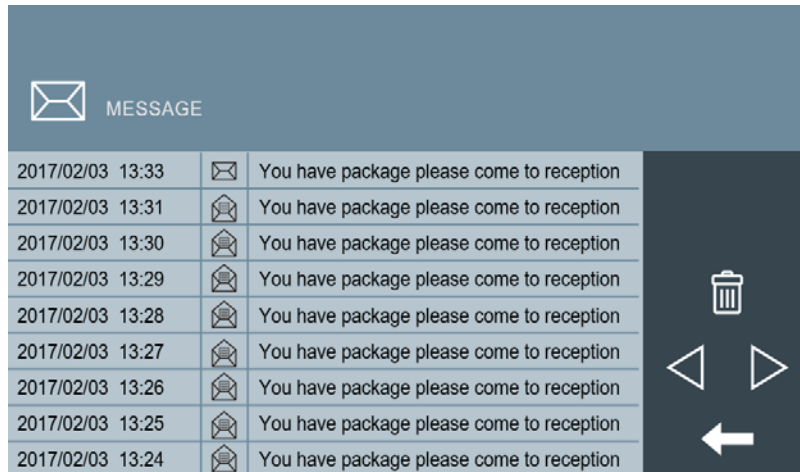

3.15 SOS

Touch the SOS button and hold it for 3 seconds. The monitor displays a message indicating SOS SENT, the Guard Unit and management software will receive SOS alarm.



To enable SOS function,

“INSTALLER SETTINGS” – “ALARM SETTING” Only one zone acts as SOS in SENSOR column.

ZONE	TYPE	SENSOR	INPUT	DELAY
1	IMMEDIATE	SOS	NC	0S
2	IMMEDIATE	PANIC	NC	0S
3	IMMEDIATE	PANIC	NC	0S
4	IMMEDIATE	PANIC	NC	0S
5	IMMEDIATE	PANIC	NC	0S
6	IMMEDIATE	PANIC	NC	0S
7	IMMEDIATE	PANIC	NC	0S
8	IMMEDIATE	TAMPER	NC	0S

3.16 Actuators

Click on R1- R8, The monitor will activate corresponding relay, The RS485 port will send command data, The monitor displays a message indicating r(#) is activated, R1- R8 can be set at 'RELAY CONTROL' web of the monitor.

REMARK: F01616 (10 relay module) connect the RS485 port of the monitor, The address of module address must be set to 1).

RELAY	DESCRIPTION
R1	RELAY 1
R2	RELAY 2
R3	RELAY 3
R4	RELAY 4
R5	RELAY 5
R6	RELAY 6
R7	RELAY 7
R8	RELAY 8

3.17 Scenes Control

The resident can set four different preset scenarios by clicking on the respective icon. Hi level integration is required through RS-485.



3.18 Do Not Disturb

Do not disturb function will make any call received to be silent. Only the screen will lit when a call is received. It can be activated for given periods of time, after which the monitor will return to normal mode. The notification LED is on when do not disturb is enabled.

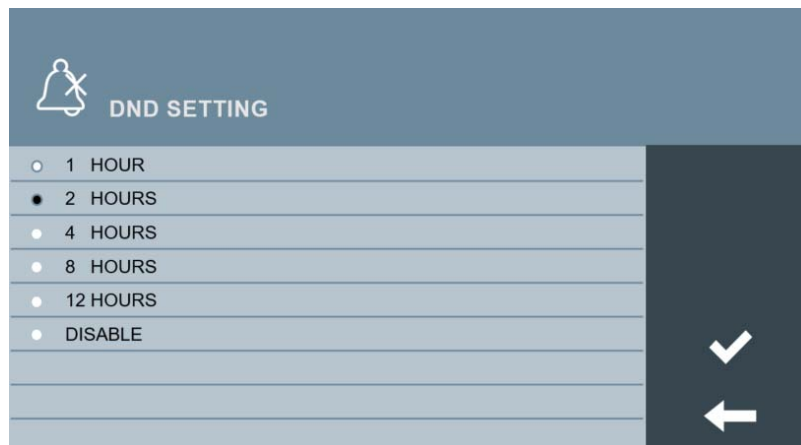

3.19 Ringtone Setting

The resident can select an independent ringtone for the 3 different call sources and its volume by the ringtone settings menu.

REMARK: 5 ringtones choices are available. OTHER is used for 1W panel and general entrance panel. Doorbell input will always trigger DING DONG sound.

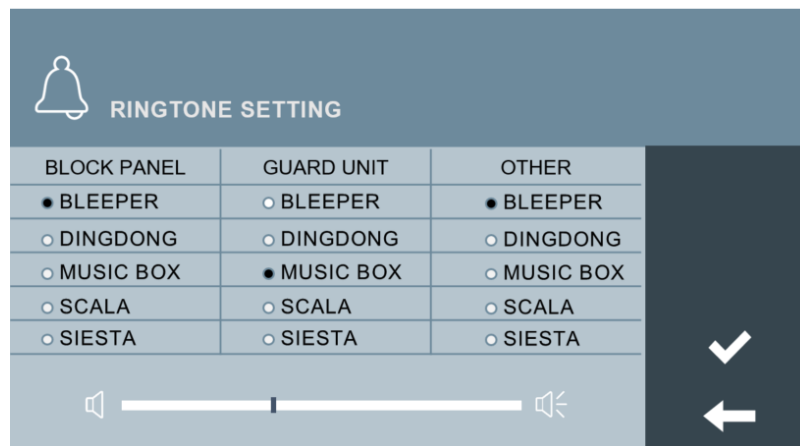

3.20 Screen Setting

The resident can select the background screen color and activate the touch screen click tone on the screen setting menu.

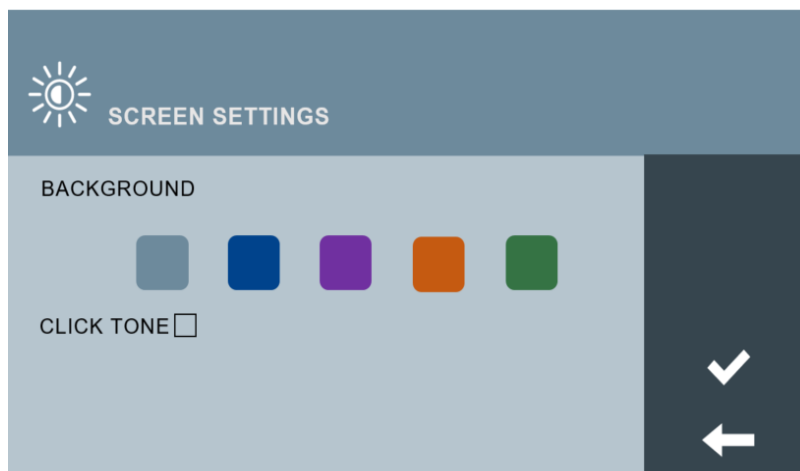

3.21 Language Setting

The resident can select language by the language setting menu. (available languages depend on the FW version).

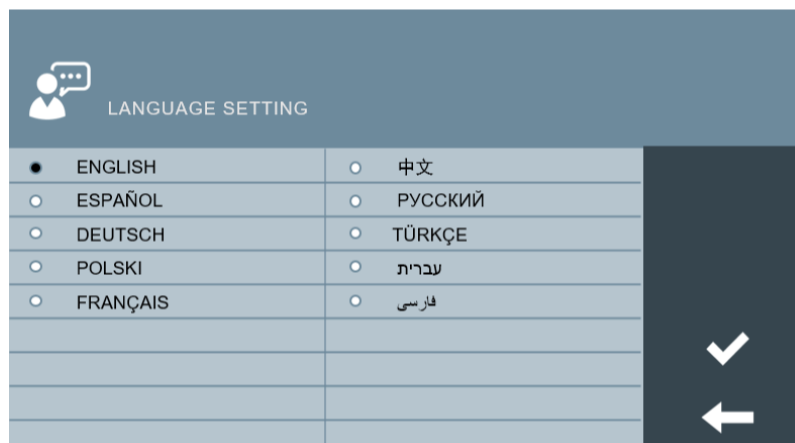

3.22 Date/Time Setting

If the projet has MEET Management Software, the monitor time is synchronized with the one in the PC that is connected to the same local network. This sychronization is not automatic, so it will take about 5 minutes to take effect. Even date and time that is displayed in the monitor comes from the PC, the monitor takes into account the parameters of GMT and DST set in the monitor.

If the projet does not have MEET Management Software, the date and time displayed in the monitor will be the one set at TIME SETTINGS parameter. **Do not use the parameter TIME ZONE in this case.**

If the monitor is connected to internet and there is not mangement software, date and time in the monitor are automatically sincronized with internet.

REMARKS:

Date and time will be lost after a power failure or reset in the monitor, but date format and DST will be kept.

DST check box forwards the time in one hour.This change is not automatic.

After a reset or a power failure in the monitor, wait for 2 minutes at least before program any change in date and time parameters.

DATE/TIME SETTING			
DATE SETTING			
FORMAT	<input checked="" type="radio"/> DD/MM/YYYY	<input type="radio"/> MM/DD/YYYY	<input type="radio"/> YYYY/MM/DD
DATE	01	01	2018
TIME SETTING			
TIME	00	00	00
TIME ZONE			
	GMT+01:00		DST <input type="checkbox"/>

3.23 Alarm Pincode Setting

The resident can modify the alarm pincode and distress pincode by the alarm pincode setting menu.

ALARM PIN	
ALARM PIN <input checked="" type="checkbox"/>	
CURRENT PIN	
NEW PIN	
CONFIRM PIN	
DISTRESS PIN <input type="checkbox"/>	
CURRENT PIN	
NEW PIN	
CONFIRM PIN	

REMARK: Default alarm pincode is 1234 and distress pincode is 4321.

3.24 Installer Settings

Touch Installer Settings icon, enter the installer pincode.

REMARK: Default installer pincode:6666.

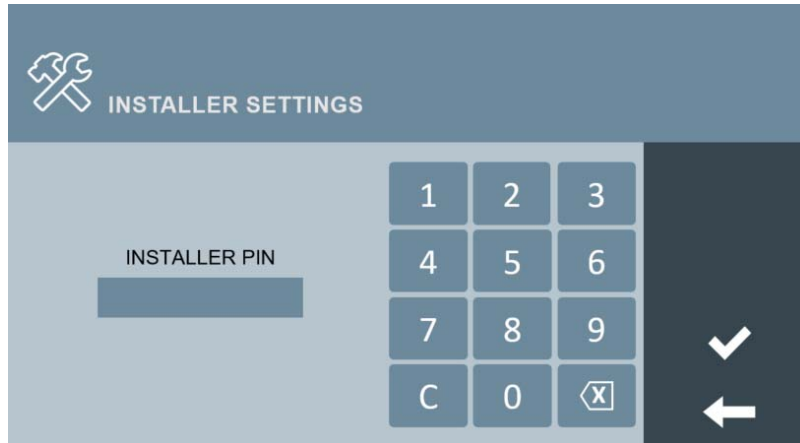

Installer Settings Main Screen.

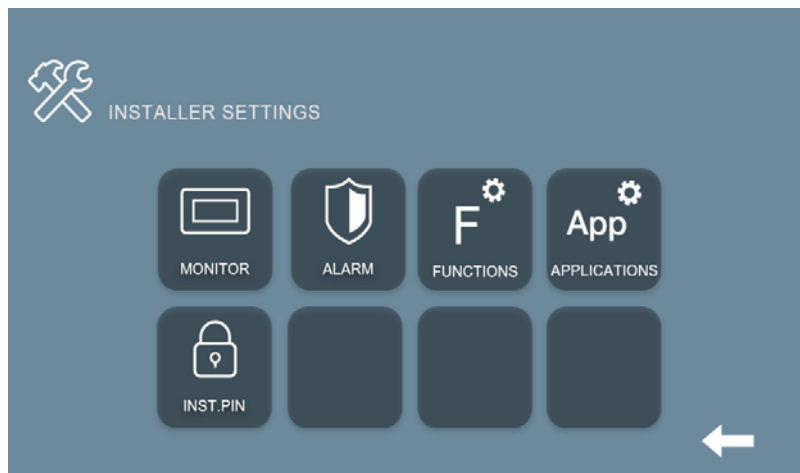

3.24.1 Monitor Settings

BLOCK: 3 digits (001-999) = block number.

APARTMENT: 4 digits (0001-9899) = apartment number

MONITOR: 1 digit (0-9) = number of monitors per apartment.

REMARK: There must always be a monitor with the extension 0 at each apartment.

SYNC CODE: synchronization code for monitor extension on the same apartment.

Synchronization code must be the same.

SOFTWARE IP: IP address of PC where MEET management software is installed. (default option 10.0.0.200).

SW.PIN: The pin code is to be used when the panel is registered in MEET management software.

NETWORK SETTINGS: Setting the IP address, Mask, gateway and DNS server.

REMARK: MEET allows to the installer to define the IP range according to the project needs and make the network management easier. MEET panel network mode is static mode. Ensure that each device has a unique IP address in same installation. The devices (digital panel, monitor and guard unit) will show IP conflict if there same IP is used on the same LAN.

MONITOR SETTINGS			
BLOCK	1	SYNC CODE	123456
APARTMENT	0101	SOFTWARE IP	10.0.0.200
MONITOR	0	SW.PIN	*****

NETWORK SETTINGS			
IP	10.1.1.1	GATEWAY	10.254.0.1
MASK	255.255.255.0	DNS	8.8.8.8

3.24.2 SIP Settings

ENABLE: Enable or disable sip function.

SIP SERVER: IP address of Sip server.

DOMAIN: Sip server domain.

STUN IP: Audio and video NAT traversing public network server IP.

STUN PORT: The port of audio and video NAT traversing public network server **SIP USER:** The username of sip account.

SIP PASS: The password of sip account.

REMARK: When the monitor is used as a sip device, use the SIP account to call SIP devices or to receive calls from other SIP devices. SIP function has to be enabled.

SIP SETTINGS	
ENABLE	<input type="checkbox"/>
SIP SERVER	SIP:192.168.12.40
DOMAIN	192.168.12.40
STUN IP	192.168.12.40
STUN PORT	5060
SIP USER	100
SIP PASS	*****

3.24.3 Alarm Setting

■ ALARM Setting (only when installed).

Monitor built-in a 8 Zone alarm management option.

NOTE: 1-7 ZONE for sensor, 8 ZONE only for tamper. (Zones 9-16 not available in this version)

Zone alarm type, sensor, input and delay information set each sector.

TYPE: delay, panic, immediate.

NOTE: When the type is panic, the alarm information is sent to guard unit and MEET management software, the monitor will not produce alarm sound.

SENSOR: smoke,gas,ir,door>window,panic,tamper,sos.

INPUT: 3C,NO,NC,BELL.

3C is used for sensor loop protect and need one match resistance (2.2K) provided with the monitor. The alarm will be activated if the resistance value of the loop changes.

NO for the sensor loop is Normally Open.

NC for the sensor loop is Normally Closed.

BELL for door bell.

DELAY: 0-60s.

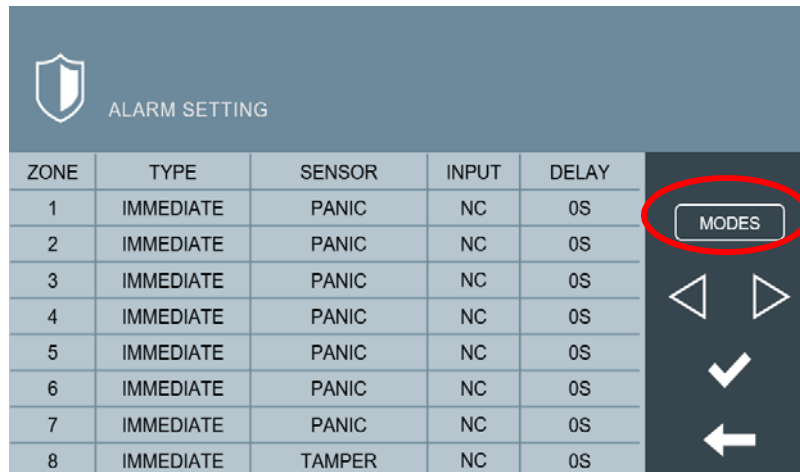

ZONE	TYPE	SENSOR	INPUT	DELAY
1	IMMEDIATE	PANIC	NC	0S
2	IMMEDIATE	PANIC	NC	0S
3	IMMEDIATE	PANIC	NC	0S
4	IMMEDIATE	PANIC	NC	0S
5	IMMEDIATE	PANIC	NC	0S
6	IMMEDIATE	PANIC	NC	0S
7	IMMEDIATE	PANIC	NC	0S
8	IMMEDIATE	TAMPER	NC	0S

3.24.4 Modes Setting

Select which zones from Zone1 to Zone 8 will be armed when activating each alarm mode HOME, SLEEP or OUT. LOOP DETECT option only for 1-8 zone in monitor 0. Loop detection will be performed when households switch to SLEEP or OUT mode.

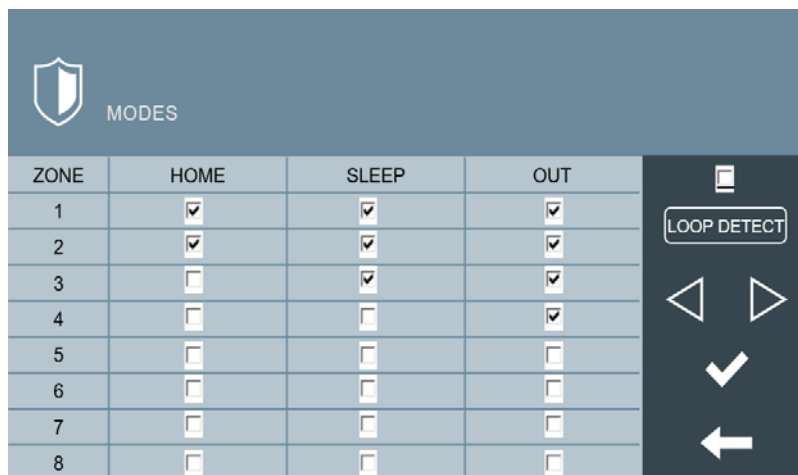

ZONE	HOME	SLEEP	OUT
1	<input checked="" type="checkbox"/>	<input checked="" type="checkbox"/>	<input checked="" type="checkbox"/>
2	<input checked="" type="checkbox"/>	<input checked="" type="checkbox"/>	<input checked="" type="checkbox"/>
3	<input type="checkbox"/>	<input checked="" type="checkbox"/>	<input checked="" type="checkbox"/>
4	<input type="checkbox"/>	<input type="checkbox"/>	<input checked="" type="checkbox"/>
5	<input type="checkbox"/>	<input type="checkbox"/>	<input type="checkbox"/>
6	<input type="checkbox"/>	<input type="checkbox"/>	<input type="checkbox"/>
7	<input type="checkbox"/>	<input type="checkbox"/>	<input type="checkbox"/>
8	<input type="checkbox"/>	<input type="checkbox"/>	<input type="checkbox"/>

3.24.5 FUNCTIONS

This function can be used by the installer to enable/disable the options available on the monitor. The icon will not disappear, and a “Function not activated” will be displayed. By default all functions are enabled.

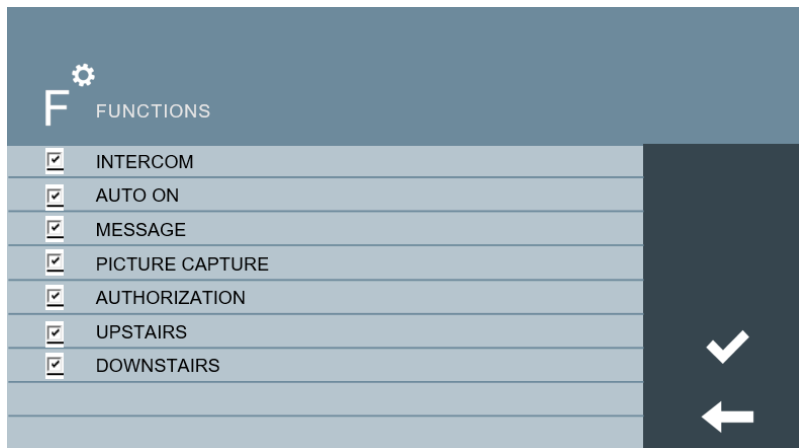

3.24.6 APP Applications

The Monitor can choose the APPs to be shown on the main menu.

- Positions 1-5 : MEET pre-installed APP. The icon is predefined.
- Positions 6-8 : Third party preinstalled APPs (only in version 2.1 or higher)

The numbers of selected APP must be always 3, otherwise saving process will be unsuccessful.

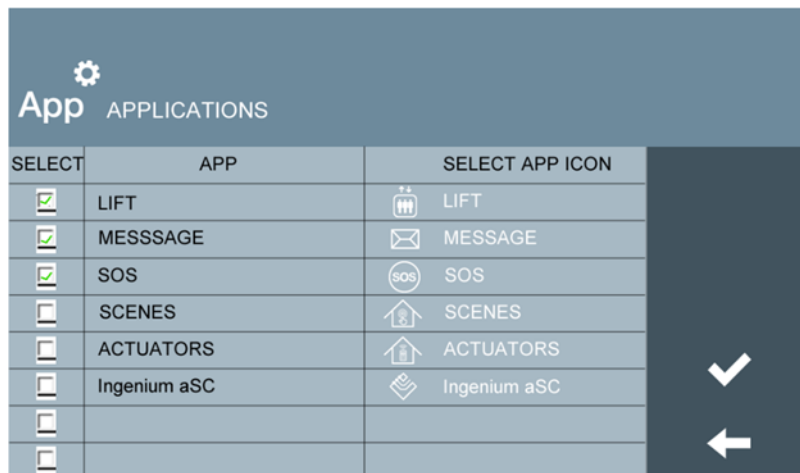

Only APP positions from 6 to 8 can select app icon from 9 optional icons.

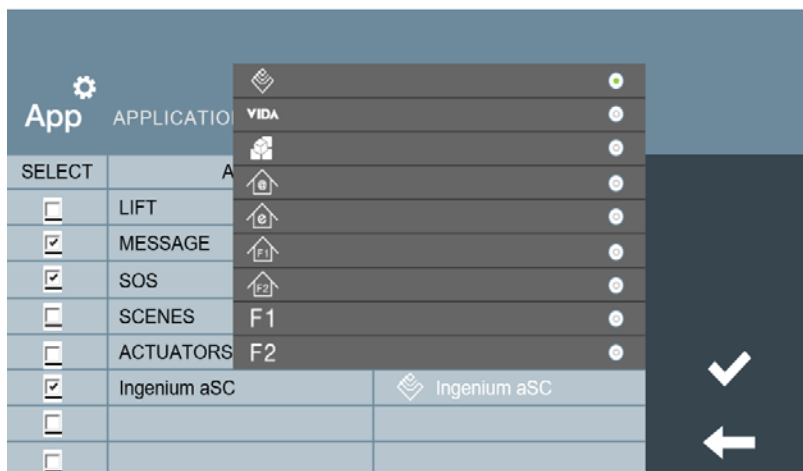

3.25 About

You can get the following information: device name, firmware version, device, MAC address, IP address about the monitor.



4 Configuration via Web Server

The monitor has an integrated web server, which allows to configure the parameters. This web server is accessed via the monitor's IP address.

The browser opens with the configured IP address of the monitor. A screen opens requesting a username and password.

Default IP: 10.1.1.1

Username: admin

Password: 6666

4.1 Device Information

The following information is displayed: the device name, firmware version, Device info, MAC address, IP address.

DEVICE	DEVICE INFO
GENERAL	
NETWORK	FERMAX MEET MONITOR
IP CAMERA	FIRMWARE: V02.10X
SIP	DEVICE:001-0101-0
ADVANCED	MAC:BC:F8:11:0A:5F:85
ACTUATORS	IP:10.1.1.1
VERIFICATION	COPYRIGHT © FERMAX ELECTRONICA S.A.U
PINCODE	www.fermax.com
RESTORE	
LOG OUT	

4.2 General Settings

4.3 BLOCK: 3 digits (001-999) = block number.

APARTMENT: 4 digits (0001-9899) = apartment number

MONITOR: 1 digit (0-9) = number of monitors per apartment.

REMARK: There must always be a monitor with the extension 0 at each apartment.

SYNC CODE: synchronization code for monitor extension on the same apartment.

Synchronization code must be the same.

DEVICE	GENERAL SETTINGS
GENERAL	
NETWORK	
IP CAMERA	
SIP	
ADVANCED	
RELAY CONTROL	
VERIFICATION	
PINCODE	
RESTORE	
LOG OUT	

BLOCK:	<input type="text" value="1"/>
APARTMENT:	<input type="text" value="101"/>
MONITOR:	<input type="text" value="0"/>
SYNC CODE:	<input type="text" value="123456"/>
	<input type="button" value="SAVE"/>

4.4 Network Settings

MEET system allows the installer to define the IP range according to the projects needs making the network management easier. monitor network mode is static mode. Ensure that each device has a unique IP address in same installation. The devices will show IP conflict if there are same IP.

IP: IP address of the monitor (default option 10.1.1.1).

MASK: Subnet mask of the monitor (default option 255.0.0.0).

GATEWAY: Default gateway of the monitor (default option 10.254.0.1).

DNS: DNS of the monitor (default option 8.8.8.8).

SOFTWARE IP: IP address of PC where MEET management software is installed. (default option 10.0.0.200).

SW.PIN: The pin code is to be used when the panel is registered in MEET management software.

DEVICE	NETWORK SETTINGS
GENERAL	
NETWORK	
IP CAMERA	
SIP	
ADVANCED	
RELAY CONTROL	
VERIFICATION	
PINCODE	
RESTORE	
LOG OUT	

IP:	<input type="text" value="10.1.1.1"/>
MASK:	<input type="text" value="255.0.0.0"/>
GATEWAY:	<input type="text" value="10.254.0.1"/>
DNS:	<input type="text" value="8.8.8.8"/>
SOFTWARE IP:	<input type="text" value="10.0.0.200"/>
SW. PIN:	<input type="text" value="*****"/>
	<input type="button" value="SAVE"/>

4.5 IP Camera Settings

This function allows to configure IP CCTV cameras using RTSP protocol. IP cameras must be added manually.

NUMBER OF CAMS: IP camera Number. Up to 8 different cameras.

CAMERA 1: IP camera name.

CCTV RELAY: When the IP camera is on, the resident can open door via the unlock key on the monitor. The selected relay of F01491 will be activated when the door lock is released.

URL: rtsp://user:password@ip address of ip camera.

user:password: for cameras that require a username and password for connection. These fields are optional and depends on the RTSP stream of each IP camera.

DOOR BELL CAMERA: The monitor will display the video of the selected IP camera when the doorbell is activated.

DEVICE	IP CAMERA SETTINGS	
GENERAL		
NETWORK		
IP CAMERA		
SIP		
ADVANCED		
RELAY CONTROL		
VERIFICATION		
PINCODE		
RESTORE		
LOG OUT		

NUMBER OF CAMS:	<input type="text" value="2"/>
CAMERA 1:	<input type="text" value="TENNIS COURT"/> CCTV RELAY: <input type="text" value="DISABLE"/>
URL:	<input type="text" value="rtsp://admin:12345@10.10.10.10"/>
CAMERA 2:	<input type="text" value="Entrance Hall"/> CCTV RELAY: <input type="text" value="2"/>
URL:	<input type="text" value="rtsp://admin:12345@10.10.10.11"/>
DOOR BELL CAMERA:	<input type="text" value="2"/>
	<input type="button" value="SAVE"/>

4.6 SIP Settings

ENABLE SIP: Enable or disable sip function.

SIP SERVER: SIP server IP address.

DOMAIN: Sip server domain.

OUTBOUND: Some servers are used when NAT is active on the router.

STUN IP: Audio and video NAT traversing public network server IP.

STUN PORT: The port of audio and video NAT traversing public network server.

SIP USER: The username of sip account.

SIP PASS: The password of sip account.

CONVERSATION: Conversation duration, 120s, 300s, 600s, 1200s and 1800s optional.

REMARK: When the panel is used as a sip device, use quick dial to call SIP devices or receive calls from other SIP devices. SIP function has to be enabled.

DEVICE	SIP SETTINGS
GENERAL	
NETWORK	
IP CAMERA	
SIP	
ADVANCED	
RELAY CONTROL	
VERIFICATION	
PINCODE	
RESTORE	
LOG OUT	

ENABLE SIP:	<input type="checkbox"/>
SIP SERVER:	sip:192.168.12.40
DOMAIN:	192.168.12.40
OUTBOUND:	sip:
STUN IP:	192.168.12.40
STUN PORT:	5060
SIP USER:	100
SIP PASS:	*****
CONVERSATION:	300s ▼
	<input type="button" value="SAVE"/>

4.7 Advanced Settings

SIP EXT: The SIP extension can be used as the extension of the Monitor. When the panel calls the monitor, the SIP extension will ring too. If one monitor or SIP extension answer, the other terminals will stop ringing. The maximum of SIP extensions is 4. (This function requires an additional SIP server on the installation, so extension numbers can be used)

URL: To call a MEET device on the system, URL: sip: sip account @ IP address of MEET device (the sip account is optional). To call a standard SIP device, URL: sip: sip account @ IP address of sip server

AUTO ANSWER: Enable or disable automatic answer. If there is no answer within 10 seconds the monitor will autoanswer.

ONU (GPON): Enable or disable the SIP penetration firewall function. Suitable for GPON infrastructures..

DTMF UNLOCK: Enables or disables DTMF unlock function.

DTMF KEY: Characters required to be entered when the monitor releases the lock on a SIP panel, such as # or *. The characters to release the lock can also be set up in the SIP panel. The monitor will send characters to release the lock on SIP panel, when the user presses the door open icon.

NUMBER OF DOORLOCKS: Numbers of release doorlocks for extended unlock function. This is related to the 4 relay module (0-4 optional).

NUMBER OF CAMERAS: Numbers of IP cameras related to the panel, that will be available to switch during panel call. (0-4 optional).

DEVICE	ADVANCED SETTINGS
GENERAL	
NETWORK	
IP CAMERA	
SIP	
ADVANCED	
RELAY CONTROL	
VERIFICATION	
PINCODE	
RESTORE	
LOG OUT	

SIP EXT:	<input type="text" value="1"/>
URL:	<input type="text" value="sip:201021@10.1.1.3"/>
AUTO ANSWER:	<input type="checkbox"/>
ONU(GPON):	<input type="checkbox"/>
DTMF UNLOCK:	<input type="checkbox"/>
DTMF KEY:	<input type="text" value="#"/>
NUMBER OF DOORLOCKS:	<input type="text" value="2"/>
NUMBER OF CAMERAS:	<input type="text" value="4"/>
	<input type="button" value="SAVE"/>

4.8 Relay Control

ENABLE: Enable or disable relay control function for R1-R8.

RELAY: R1-R8.

DESCRIPTION: The description of the relay can be defined. It will be displayed on the operation interface of the monitor.

RELAY TIME: Time that the relay will remain active. 1S,2S,3S,4S,5S,10S,30S,60S optional.

REMARK: F01616 (10 relay module) has to be connected to the RS485 port of the monitor. The address of this module must be set to 1.

DEVICE	RELAY CONTROL
GENERAL	
NETWORK	
IP CAMERA	
SIP	
ADVANCED	
RELAY CONTROL	
VERIFICATION	
PINCODE	
RESTORE	
LOG OUT	

ENABLE	RELAY	DESCRIPTION	RELAY TIME
<input checked="" type="checkbox"/>	R1	RELAY 1	1s
<input checked="" type="checkbox"/>	R2	RELAY 2	1s
<input checked="" type="checkbox"/>	R3	RELAY 3	1s
<input checked="" type="checkbox"/>	R4	RELAY 4	1s
<input checked="" type="checkbox"/>	R5	RELAY 5	1s
<input checked="" type="checkbox"/>	R6	RELAY 6	1s
<input checked="" type="checkbox"/>	R7	RELAY 7	1s
<input checked="" type="checkbox"/>	R8	RELAY 8	1s

SAVE

4.9 Verification

Activation for monitor maintenance, not for installer.

DEVICE	VERIFICATION
GENERAL	
NETWORK	
IP CAMERA	
SIP	
ADVANCED	
RELAY CONTROL	
VERIFICATION	
PINCODE	
RESTORE	
LOG OUT	

SERIAL NO.: EFADF3C661AFE233
STATUS: VERIFIED
LICENSE:

SAVE

4.10 Pincod Settings

This allows to change the pin code of the web server login.

DEVICE	PINCODE SETTINGS
GENERAL	
NETWORK	
IP CAMERA	
SIP	
ADVANCED	
RELAY CONTROL	
VERIFICATION	
PINCODE	CURRENT PIN: <input type="text"/>
RESTORE	NEW PIN: <input type="text"/>
	CONFIRM PIN: <input type="text"/>
LOG OUT	<input type="button" value="SAVE"/>

4.11 RESTORE

Restore Factory Settings: when this option is selected, all the parameters are restored to the factory configuration.

Reboot Device: Restarts the monitor. There are not changes in programmed parameters.

DEVICE	RESTORE
GENERAL	
NETWORK	
IP CAMERA	
SIP	
ADVANCED	
RELAY CONTROL	
VERIFICATION	
PINCODE	RESTORE FACTORY SETTINGS
RESTORE	<input type="button" value="OK"/>
	REBOOT DEVICE
LOG OUT	<input type="button" value="OK"/>

4.12 Log Out

Log out the webserver.

DEVICE	LOG OUT
GENERAL	
NETWORK	DO YOU CONFIRM TO LOG OUT?
IP CAMERA	
SIP	<input type="button" value="OK"/>
ADVANCED	
RELAY CONTROL	
VERIFICATION	
PINCODE	
RESTORE	
LOG OUT	

5 Installation

5.1 Schematic Diagram Of Installation

○,1The monitor connector is mounted, and the monitor connector is screwed to the wall.

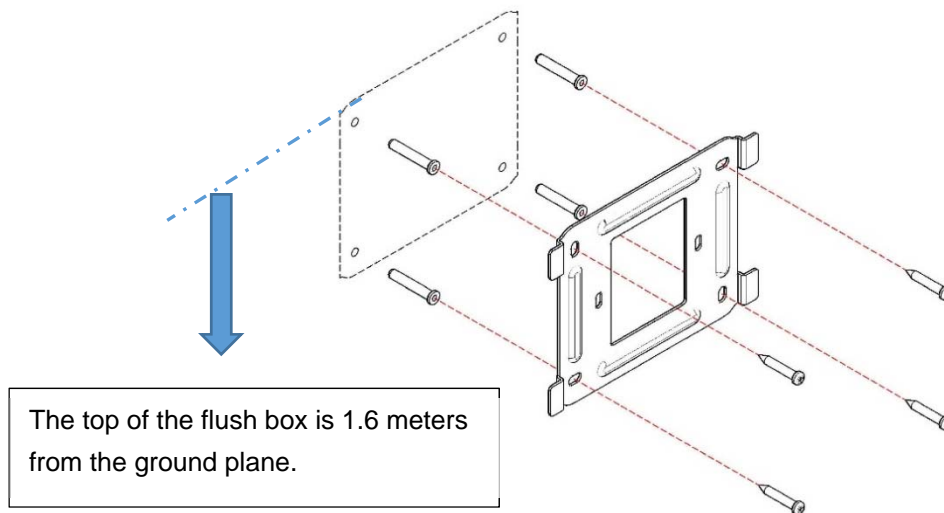

○,2Hang the monitor from the top down to the monitor connector.

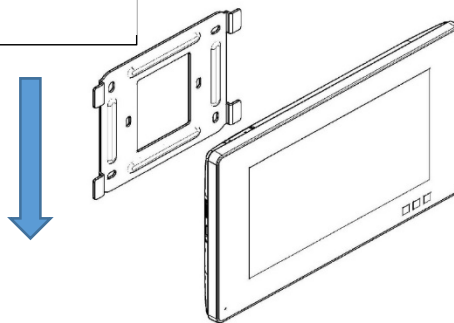

5.2 Connectors

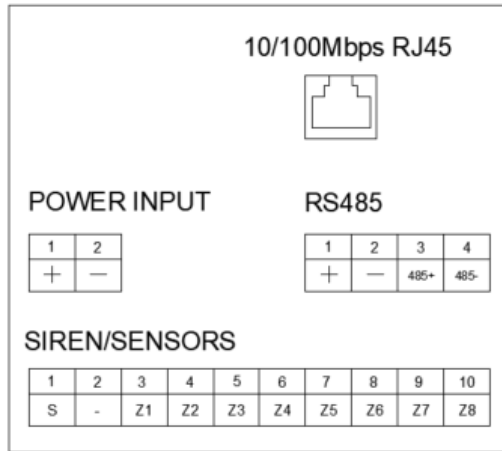

Monitor with one LAN port

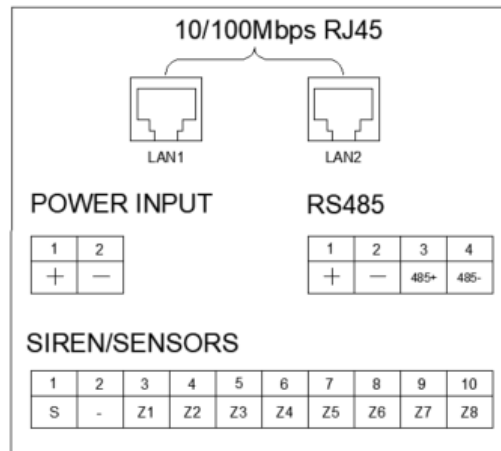

Monitor with two LAN ports
(Only Wit 10" monitor)

- 10/100Mbps RJ45 Port. PoE Power supply (Only on PoE WIT monitor).
 - +, -: 12Vdc Power Input.
 - **Siren/Sensors:**
 - s: The voltage signal will be output when the alarm is trigger Maximum current is 100mA.
 - : GND.
 - Z1-Z7: sensors input.
 - +, -, 485+, 485-: For F01616 (10 relay module) or Home Automation system.
- LAN1:** connect to Meet video door entry system, PoE Power supply (Only on PoE WIT monitor)
- LAN2:** connect to the home automation system (DHCP configuration)

5.3 Wiring Diagram For Alarm

○,1 Normally open sensor Wiring diagram.

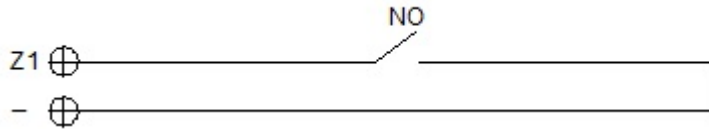

○,2 Normally closed sensor Wiring diagram.

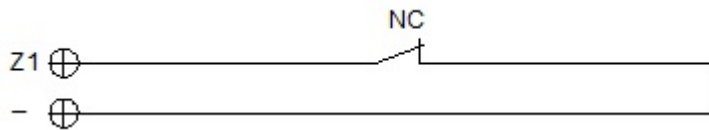

○,33C option Normally open sensor Wiring diagram.

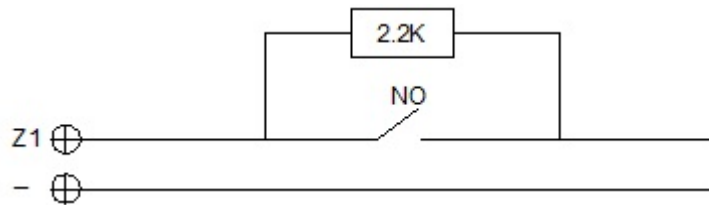

○,43C option Normally closed sensor Wiring diagram.

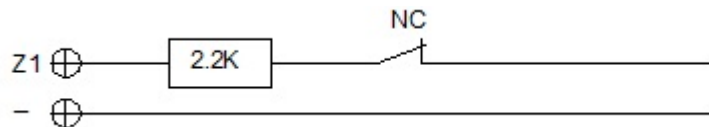

○,5 Doorbell Wiring diagram.

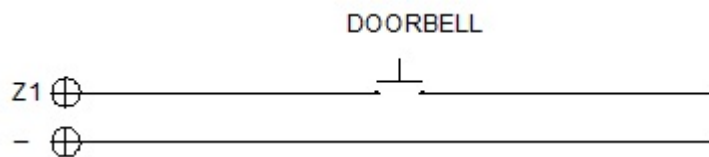

5.4 Technical Parameters

Dimensions

MIO 7" monitor(mm): 210(W)×130(H)×20(D)

WIT 7" monitor(mm): 211(W)×132(H)×20(D)

MIO 10" monitor(mm): 270(W)×168(H)×20(D)

WIT 10" monitor(mm): 270(W)×168(H)×20(D)

Power supply: 12Vdc

- 7"monitor standby current 200mA, Working current 500mA
- 10"monitor standby current 200mA, Working current 600mA

Resolution: 1024*600

Touch Screen: Capacitive technology

Maximum conversation time: 120s

Maximum record time: 30s

Maximum IP cameras: 8

Block: 001-999

Apartment: 0001-9899

Monitor: 0-9

Operating temperature: -10~55℃

Relative humidity: 20-85%, without condensation.